

Components

I 1 x Gazebo Cover

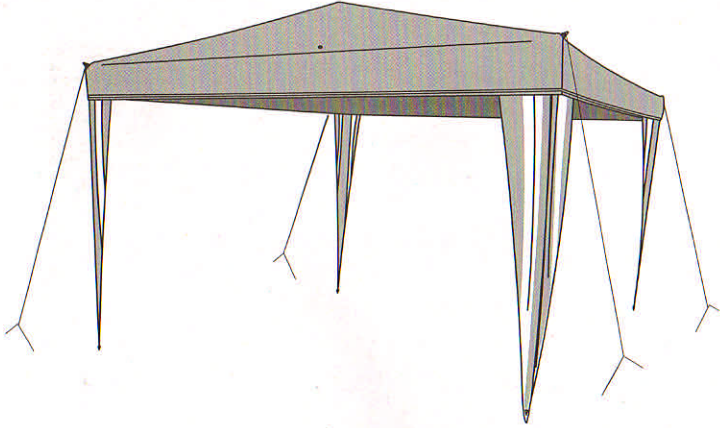

II 4 x Base Plate

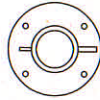

III 1 x Centre Connector

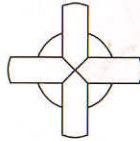

IV 4 x Corner Joint



3 x 3 Gazebo

Simple Assembly Instructions - Please keep for future reference

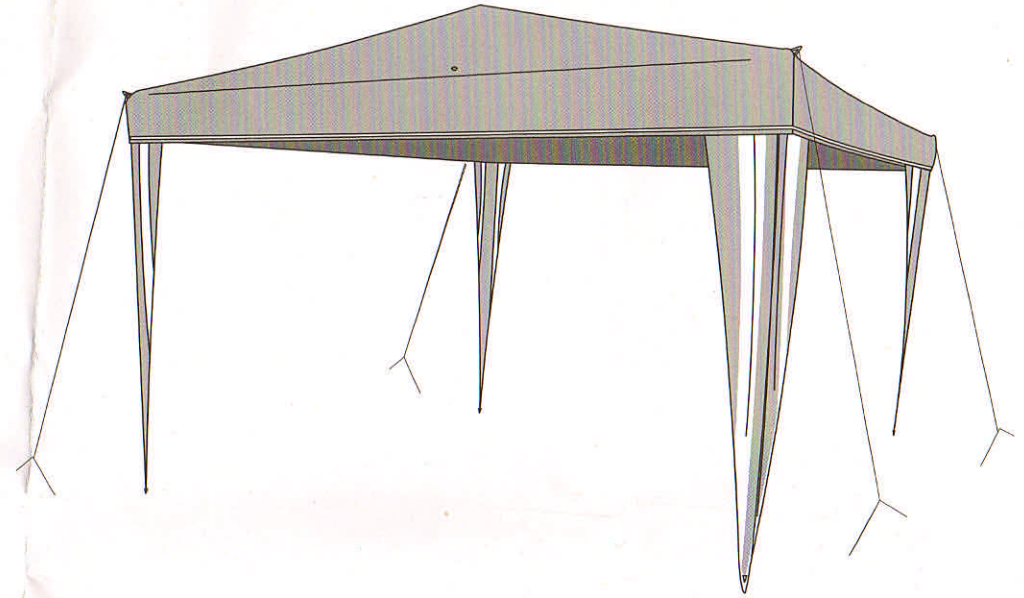

1 4 x Top Pole



1A 4 x Top Pole



2 8 x Support Pole



2A 4 x Support Pole



3 4 x Leg Pole

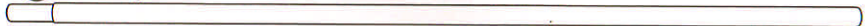

4 4 x Leg Pole



Fittings

A 8 x Peg



B 4 x Guy Rope



IMPORTANT

1. Read these instructions carefully and familiarise yourself with the procedure before assembling the unit.
2. Check that you have all the component parts following the list on the back cover and familiarise yourself with each part before proceeding.
3. Take all the fittings out of the plastic bag and separate them into their groups.
4. Ensure you have enough space to lay out all the parts before assembly.
5. To avoid scratching it is recommended that you assemble the unit on a soft level surface.

IMPORTANT SAFETY INSTRUCTIONS

Read all instruction before use and keep for future reference
Attention:

Please keep children away when assembly. Please keep children under direct supervision of adult when using.

Please do not use the gazebo under windy condition.

Always use guy rope and pegs to secure the gazebo when using.

This Gazebo is not water proof, but is shower proof.

This Gazebo is not a permanent structure and should be disassembled and stored away after use.

Do not repack your Gazebo until completely dry.

We recommend assembly by two persons under light or no wind conditions.

This Gazebo must not be left erect in windy conditions.

Keep the Gazebo Fabric away from screws, nails, staples, hooks, etc to avoid damage to the fabric and frame.



CAUTION

Fire Precautions

WARNING:

- Do not place the Gazebo near lights, fireplaces, gas or electric heaters, candles, radiators, or any other sources of heat, fire or flammable liquids.
- This Gazebo features a Fabric cover that is not flame retardant and we recommend caution and common sense when in use.
- This Gazebo can burn.
- Do not use naked flames in or around the Gazebo. We recommend you advise no smoking while inside.
- This Gazebo has no flame retardant cooking area and should not be used to house BBQs or other cooking methods.

Assembly Instructions

Stage 1 - Fitting the Support Poles

IMPORTANT: Because of the size of this unit we recommend that it is built in the place intended for use.

NOTE: Locate the unit on flat ground free from obstruction, in a sheltered area away from wind and heavy rain as this will damage the unit.

The Pegs are for location purposes only. They will not support the unit in high winds, see above.

It would be useful to ask someone to help you at this stage.

1. Insert Support Poles ②A into the Support Poles ②. Ensure all the poles are fully inserted and secure.

See fig. 1.

2. Use Corner Joints ④ to connect the Support Poles. Ensure all the poles are fully inserted and secure. Red sticker means that this end of tube should be assemble to plastic connector.

See fig. 2.

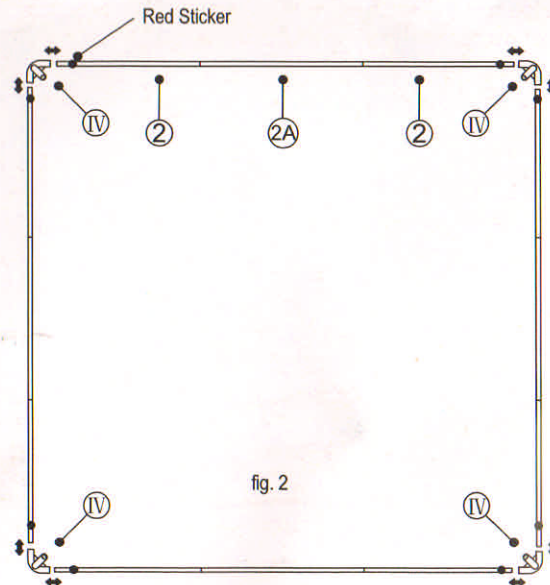
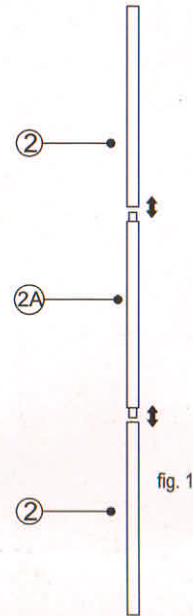

Assembly Instructions

Stage 2 - Fitting the Top Poles

NOTE: It would be useful to ask someone to help you at this stage.

1. Insert Top Poles ①A into the Top Poles ①. Ensure all the poles are fully inserted and secure.

See fig. 3.

2. Connect the Top Poles to Corner Joints ④ and Centre Connector ③.

See fig. 4.

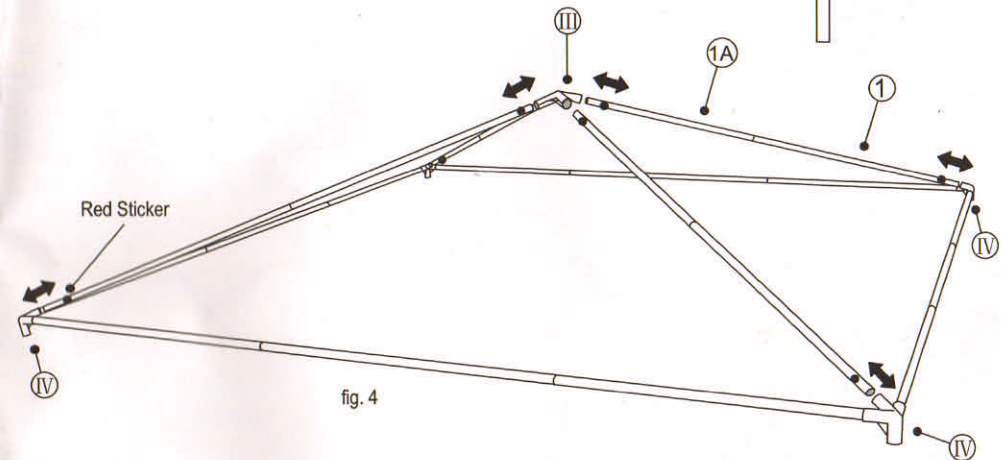
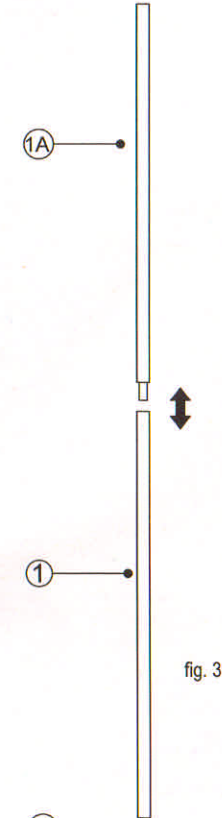

Assembly Instructions

Stage 3 - Fitting the Gazebo

NOTE: It would be useful to ask someone to help you at this stage.

1. Insert Leg Poles ③ into the unit. Ensure all the poles are fully inserted and secure. See fig. 5.

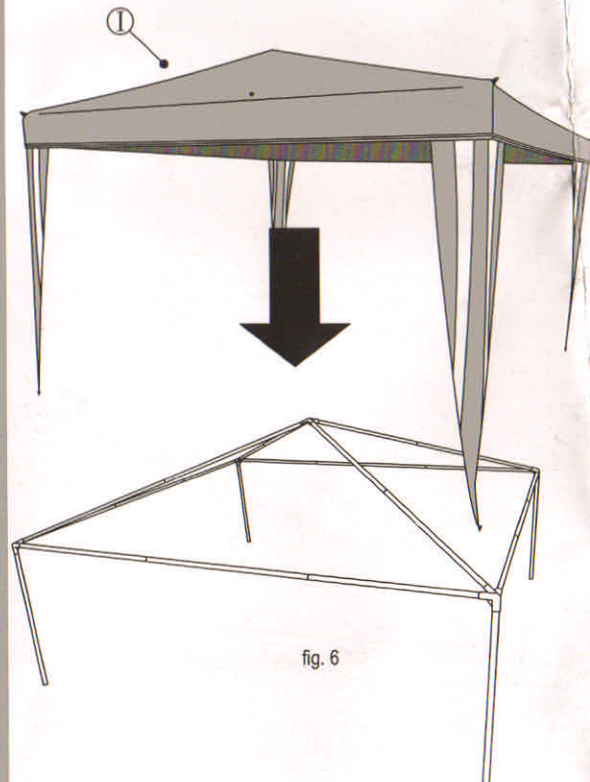
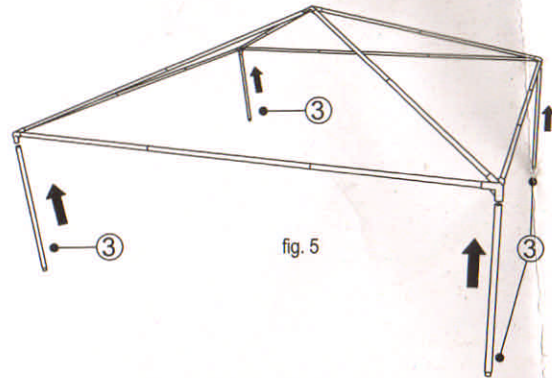

2. Carefully place the Gazebo Cover ① over the assembled roof. Then pull the Gazebo tightly over the assembled roof frame. See fig. 6.

Assembly Instructions

Stage 4 - Fitting the Legs

NOTE: It would be useful to ask someone to help you at this stage.

1. Insert the Base Plates ② onto the Leg Poles ④. Then insert the Leg Poles ④ into the unit. Ensure all the poles are fully inserted and secure. See fig. 7.
2. Use the Velcro Tapes inside the Gazebo Cover to fix it onto the assembled frame. See fig. 8 and 9.
3. Attach the Gazebo Cover's Hooks into holes on the Leg Poles ④. Tighten by moving the Hook to a lower hole. See fig. 10.

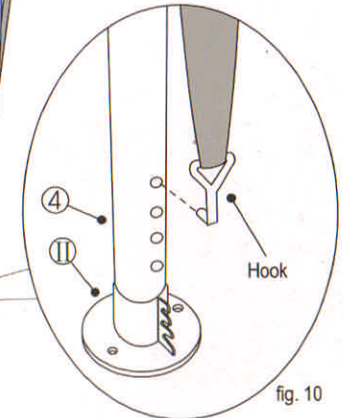
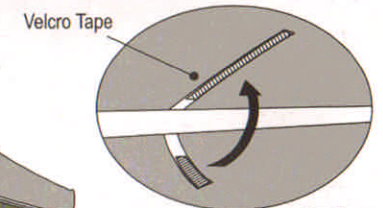
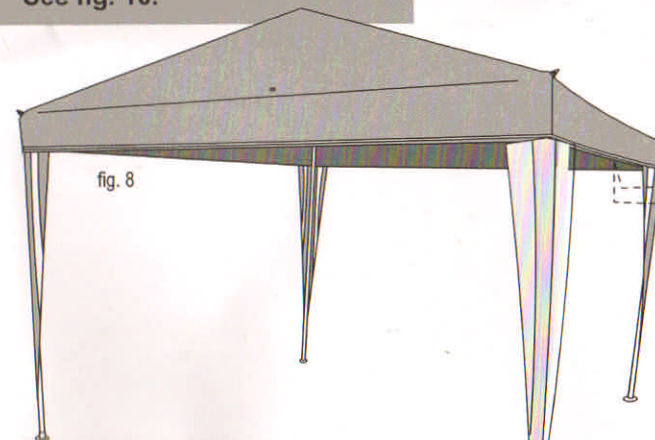
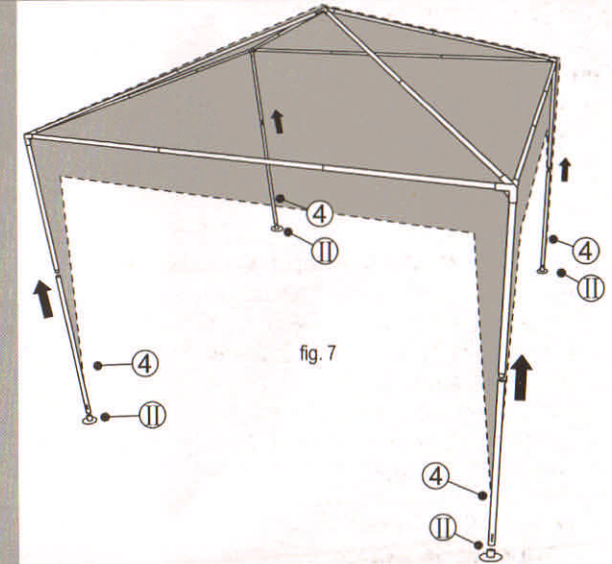

fig. 8

fig. 9

fig. 10

Assembly Instructions

Stage 5 - Fitting the Guy Ropes

NOTE: It would be useful to ask someone to help you at this stage.

1. Attach the D ring onto the Base Plates (II). Then use Pegs (A) to fix the Base Plates (II) onto the ground.

See fig. 13.

2. Attach the end of the Guy Rope (B) to the D ring on the Gazebo. Then attach one end to the Peg (A) and drive the Peg into the ground.

See fig. 11, 12 and 14.

3. Use the Same method as in fig 14 To fix the other Guy Ropes.

4. The length of Guy Ropes can be adjusted.

See fig. 15.

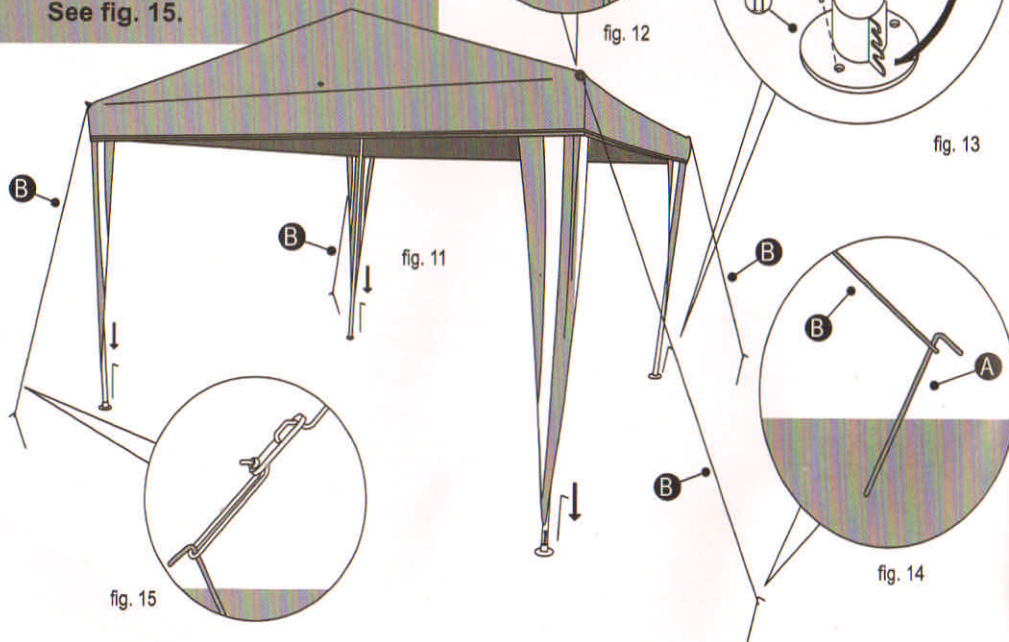

Assembly Instructions

Stage 6 - Finishing the Unit

CAUTION: Do not Assemble or Disassemble during strong winds.

1. Drainage holes prevent rain water collecting.

See fig. 16.

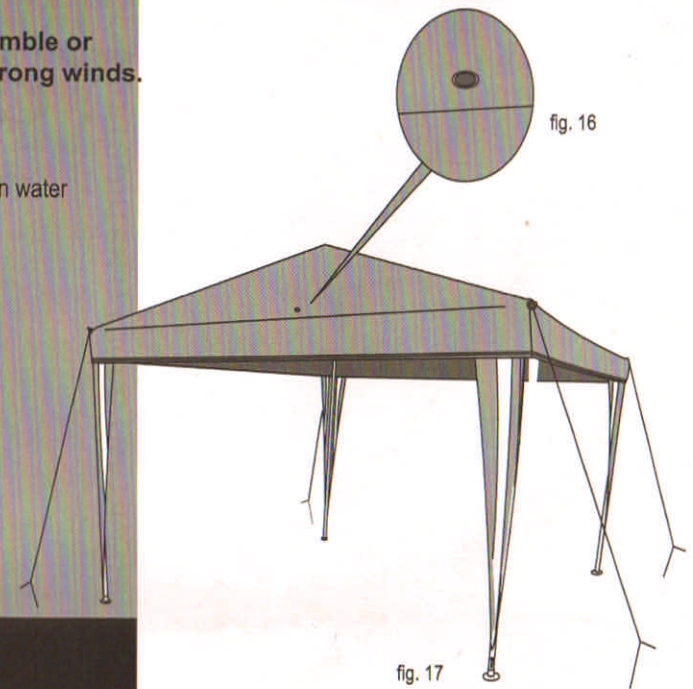

IMPORTANT:

Always use this product with caution and read the important safety instructions.

Care and Maintenance

Safety

To avoid any risk of suffocation to animals or children dispose of the plastic bags immediately.

Cleaning

As with all surfaces clean with a damp cloth and mild detergent, do not use bleach or abrasive products.

Retailer: Argos' ADD: 488-499, Avebury Boulevard, Saxon Gate Vest Center, Milton Keynes, MK9 2NW.
After-sales Telephone number: 08456 400 800